

Towards a modular LCA approach in urban wastewater system

SETAC 18th LCA Case study Symposium/ 4th NorLCA Symposium
Sustainability Assessment in the 21st century Tools, Trends &
Applications

27-11-2012

S. Morera¹, J. Comas¹, Ll. Corominas² and M. Rigola¹

1: LEQUIA, Universitat de Girona

2: ICRA (Catalan Institute for Water Research)

Index

- Introduction
- Objective
- Methodology
- Preliminary results
- Conclusions



Urban water cycle



From Current situation...

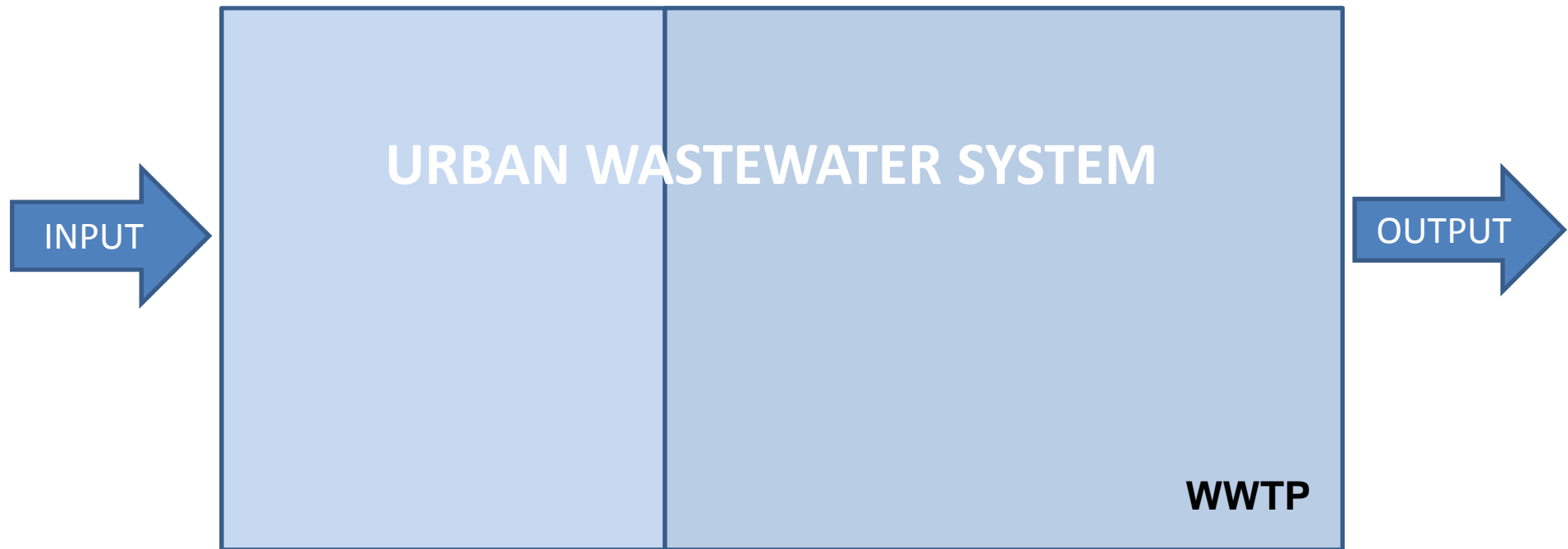

From current situation to modular CA approach

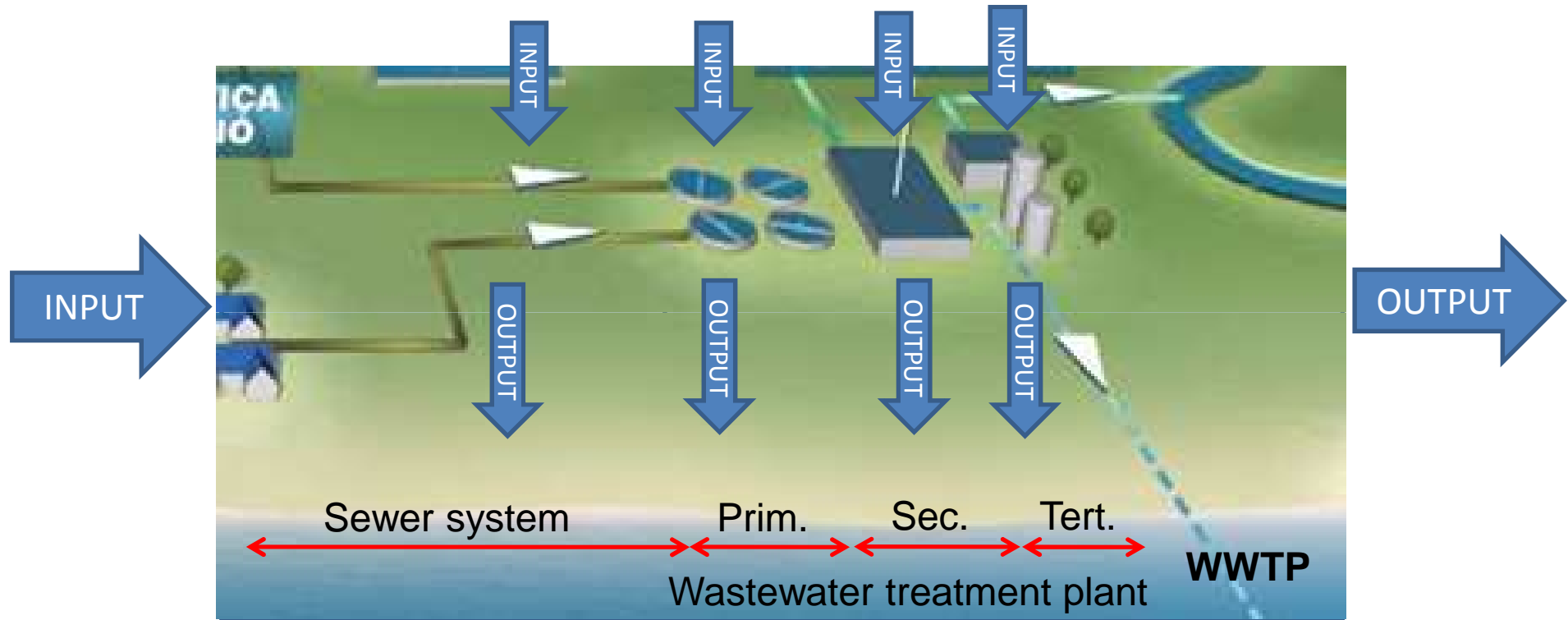

Should the sewer system be considered ?

- Sewer system construction also has an important impact
 - Excavation
 - Tubes placing
 - ...
- Sewer system operation changes a lot depending on the environment and water characteristics:
 - Electrical consumption
 - Direct GHG emissions
- In sewer systems there are also some chemical reactions that can affect the WWTP operation
 - H₂S formation



Should the sewer system be considered ?

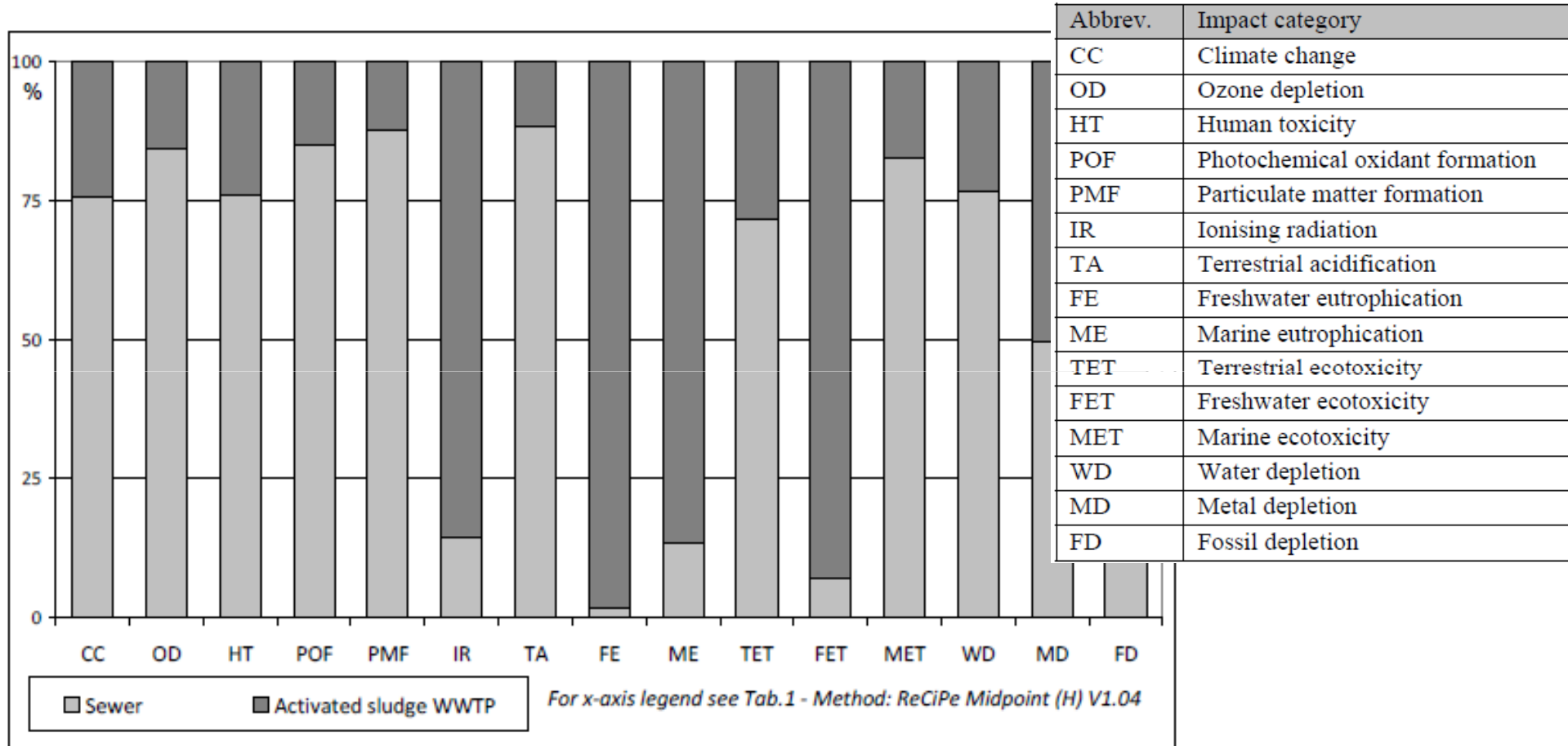

Roux et al. LCM 2011-International Conference on Life Cycle Management, August 28-31, 2011 Berlin, Germany

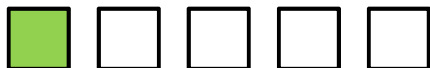

Sewer systems construction in Ecoinvent ?

- Inventories from Zimmermann et. al 1996, specific cases
- Renovation after 70 years
- Default transportation distances for material
- No consideration of land occupation to avoid double accounting
- **Modular inventories (different trenches, pipes...)**
- **Some materials need an early renovation**
- **Information about the construction process**
- **Real distances**
- **Land occupation specific for sewer system**

**Proposed
improvements**



Sewer systems operation in Ecoinvent ?

- Does not take into account direct emissions of GHG
 - Does not consider electrical consumption during operation
 - Electrical consumption is needed to pump the water
 - Direct GHGs emissions in sewer systems
- Proposed improvements

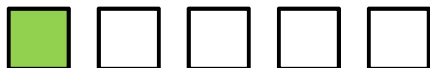

WWTP in Ecoinvent ? (construction)

- The 5 inventories are made from 2 different studies (1994 and 1995) covering 3 whole WWTPs
- Default transportation distances for material



WWTP in Ecoinvent ?

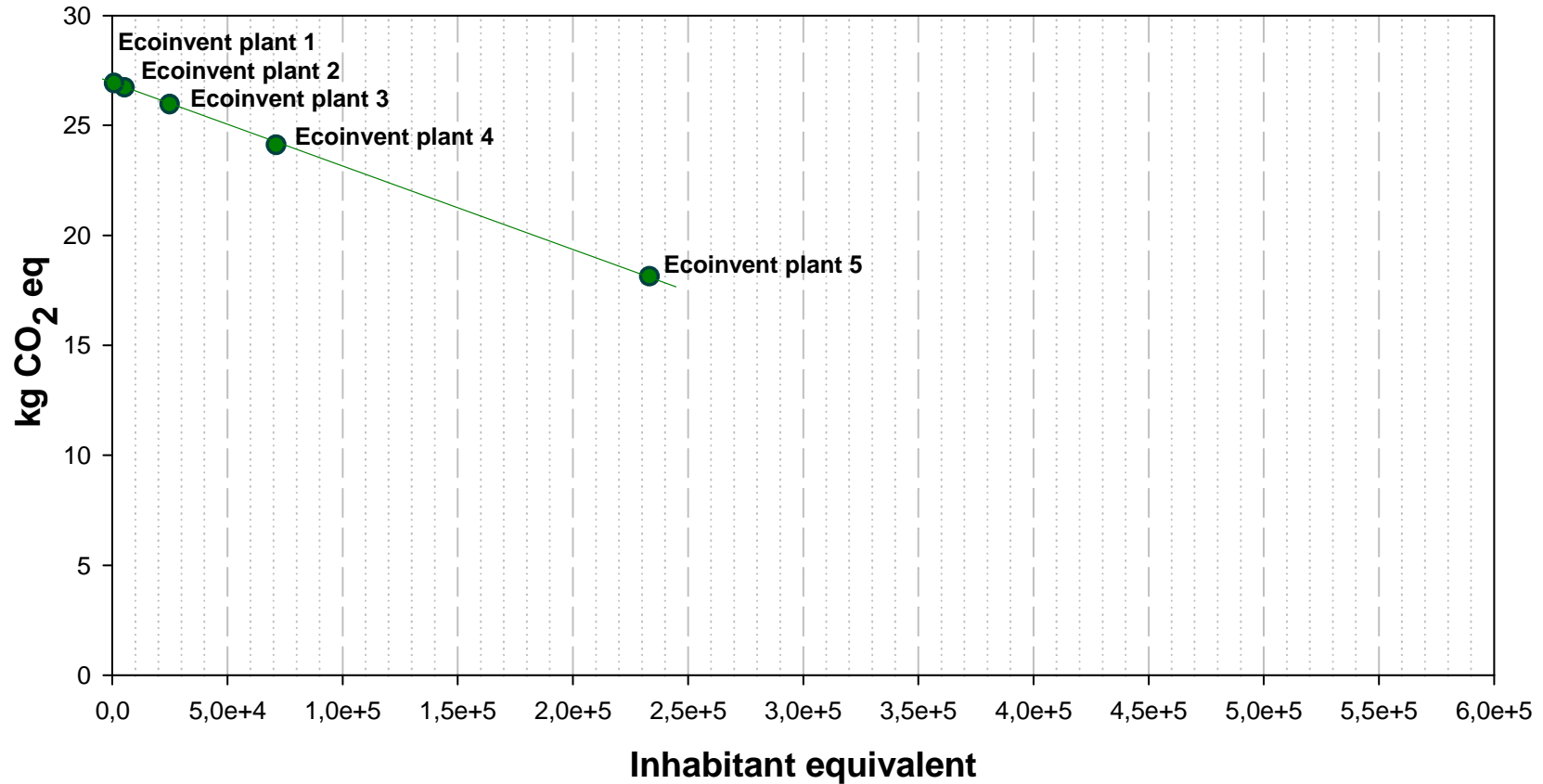

- Can be linear correlation assumed?

Corominas et. al 8th IWA Symposium on System Analysis and Integrated Assessment (WATERMATEX 2011)



WWTP in Ecoinvent ?

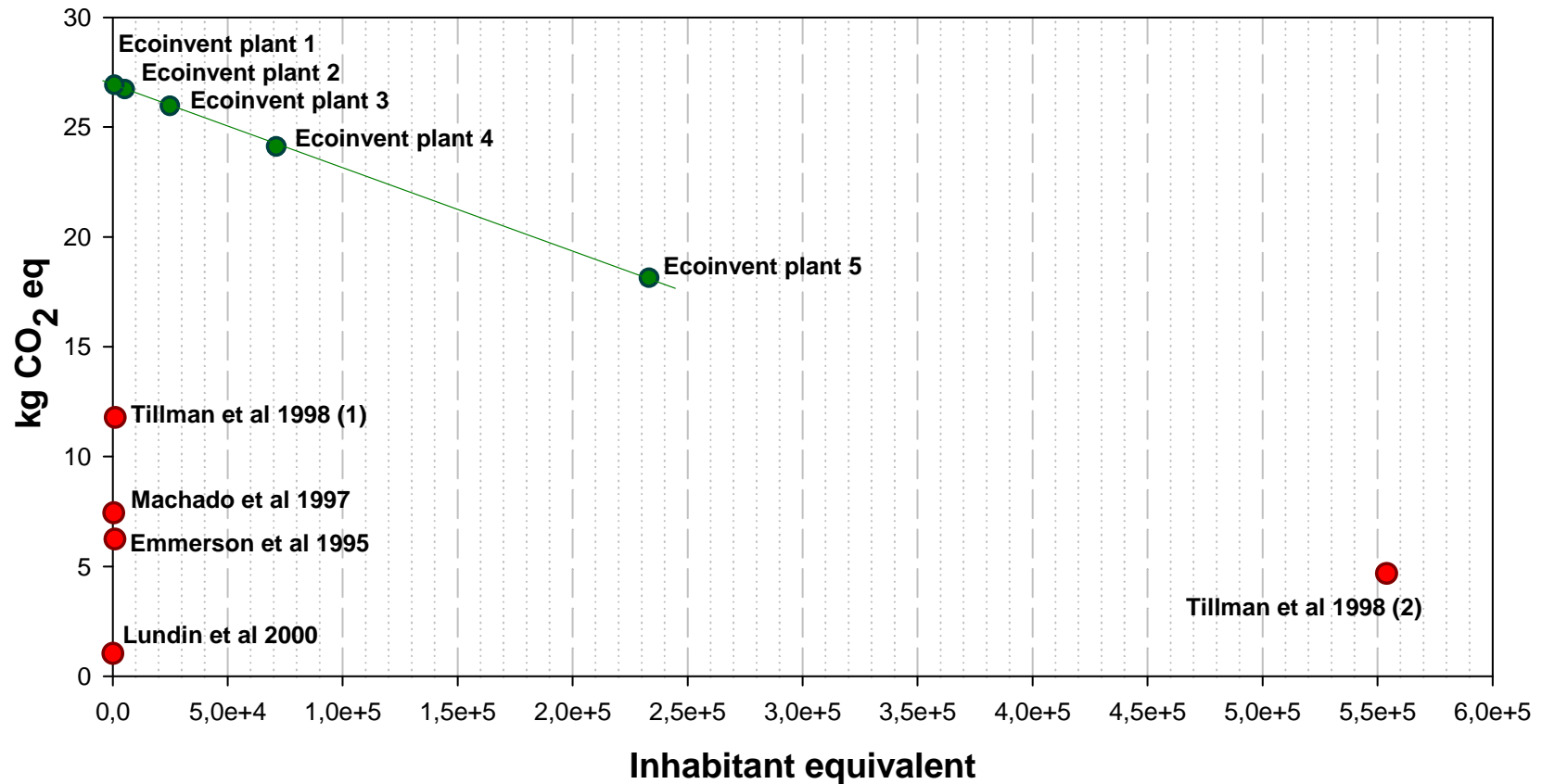

- Can be linear correlation assumed?

Corominas et. al 8th IWA Symposium on System Analysis and Integrated Assessment (WATERMATEX 2011)



WWTP in Ecoinvent ?

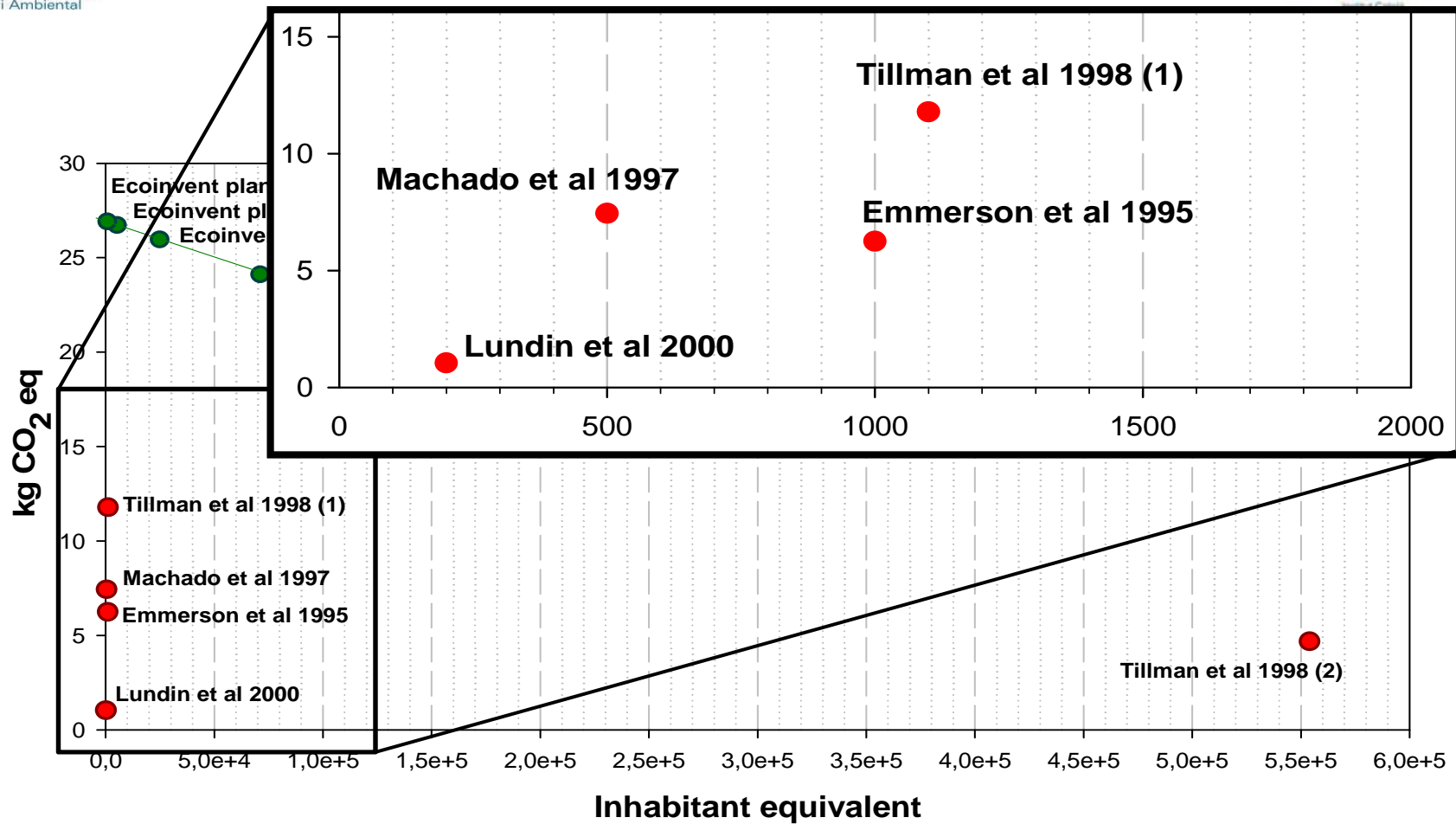

- Can be linear correlation assumed?

Corominas et. al 8th IWA Symposium on System Analysis and Integrated Assessment (WATERMATEX 2011)



WWTP in Ecoinvent ? (construction)

- The 5 inventories are made from 2 different studies (1994 and 1995) covering 3 whole WWTPs
- Default transportation distances for material

- Modular inventories for any unit process
- Standard denomination for the material
- Information about the construction process
- Real transportation distances

Proposed
improvements



WWTP in Ecoinvent database ? (operation)

- 5 different inventories of operation
- Technology: 3 stage wastewater treatment (mechanical, biological, chemical) and sludge digestion (fermentation)
- Wastewater compositions from literature/estimates

- More WWTP configurations than the conventional
 - Optimal technologies for the same unit processes depending on equivalent population
- Proposed improvements



Treatment vs. Plant size

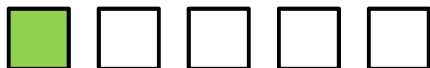
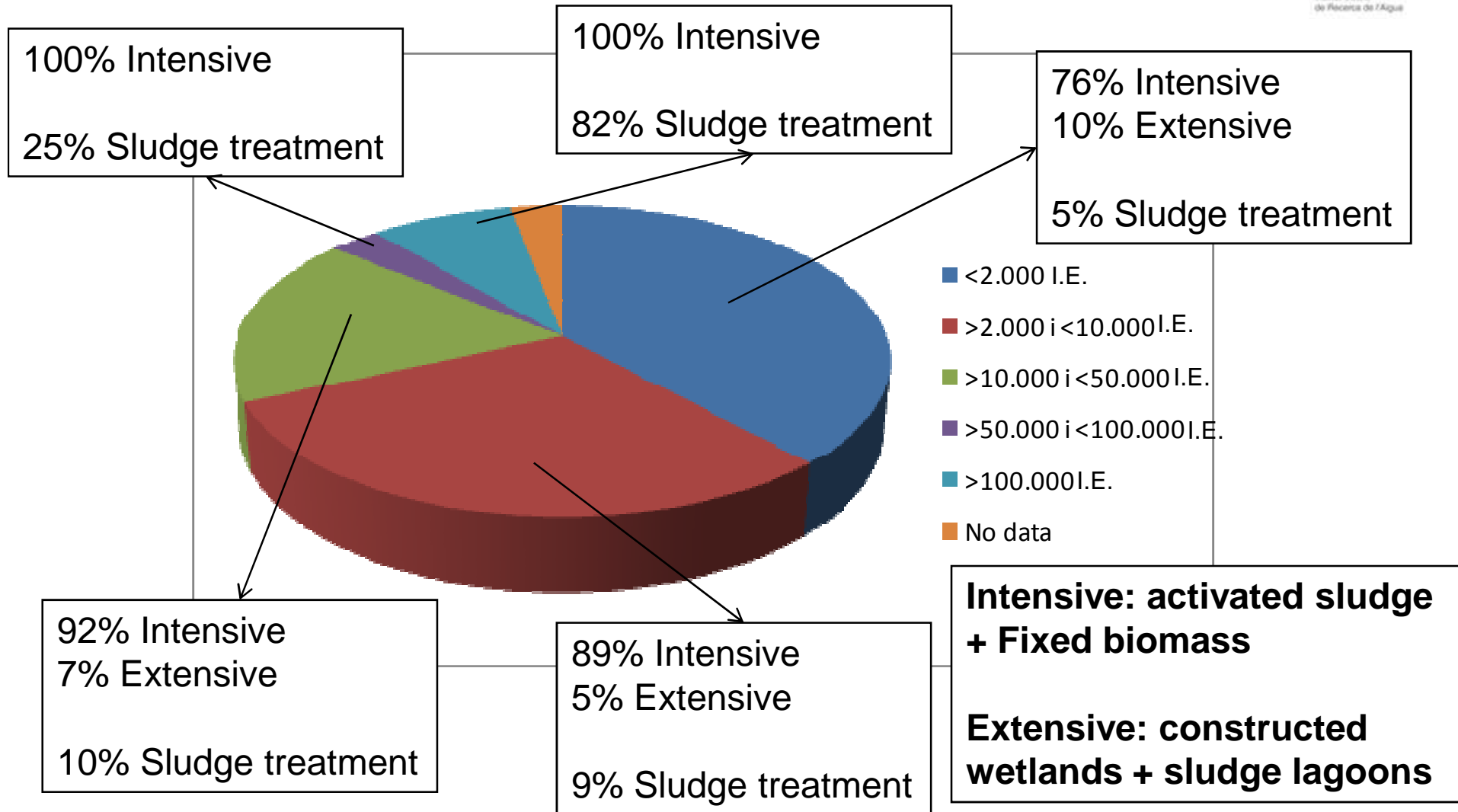

Objective of research

- Improve the inventories with a modular LCA approach for urban wastewater system
 - Creation of a better tool based on individual unit processes to assess the potential environmental impacts:
 - With different modules for any part of the system
 - User friendly
 - For LCA users, stakeholders, engineers

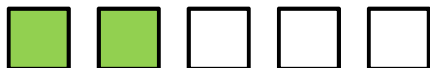
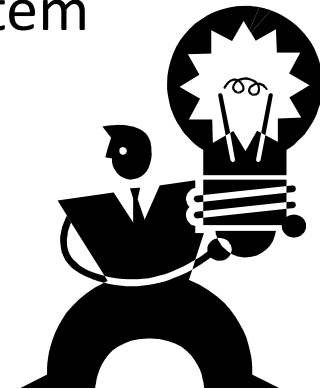

Methodology

- Sewer system
 - Meetings with builders and operators
 - Identification of typical materials and operations
 - Data collection
 - Creation of the inventories

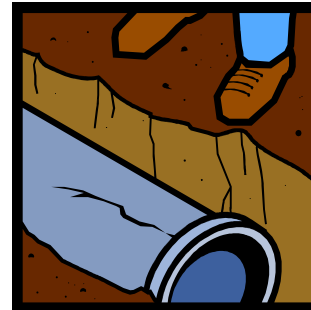
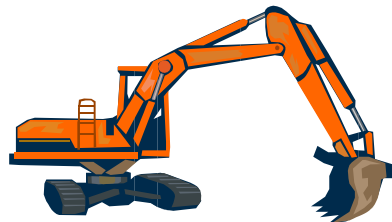

Methodology

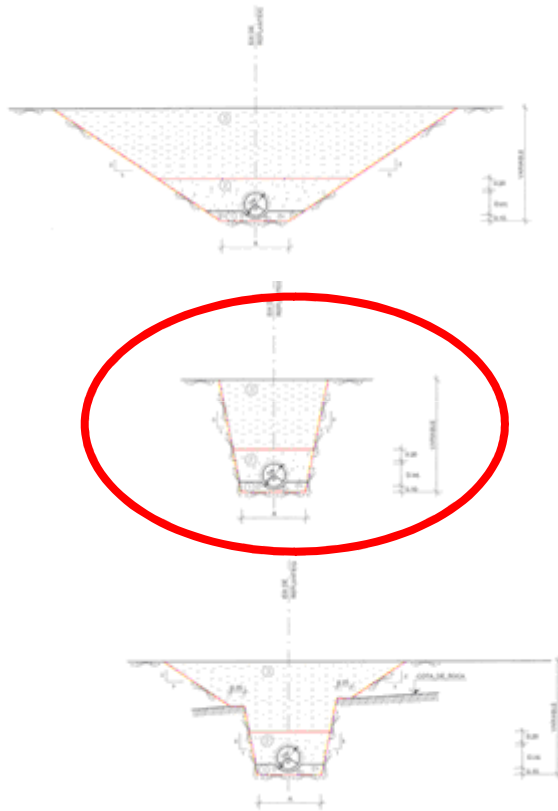

Trench

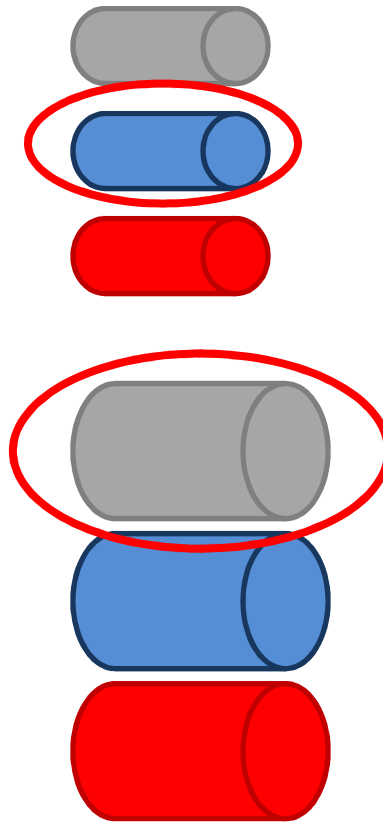

Tube

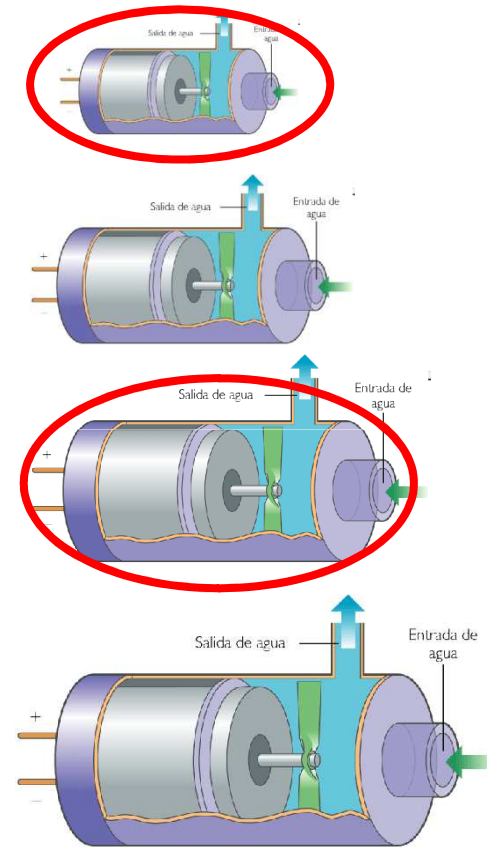

Pumps



- Wastewater treatment plants:
 - Analyze typical WWTP
 - Selection of WWTP to work with
 - Meetings with WWTP builders and operators
 - Data collection
 - Generation of every module for wastewater treatment

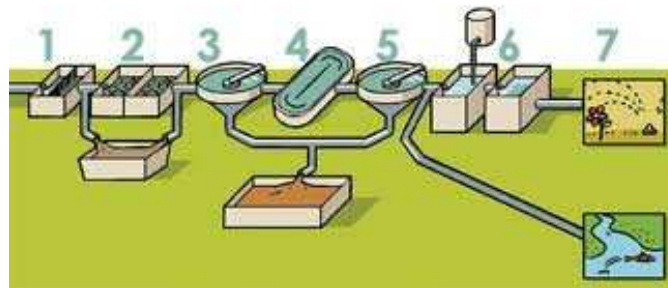

Methodology

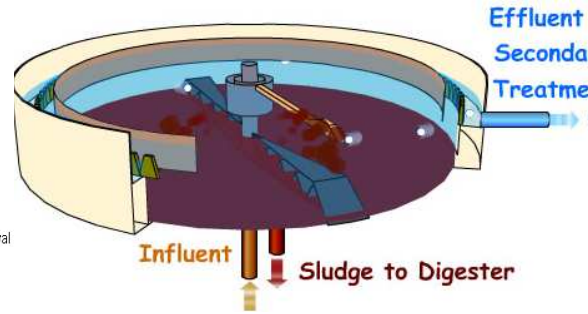
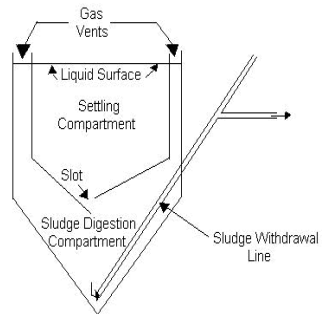
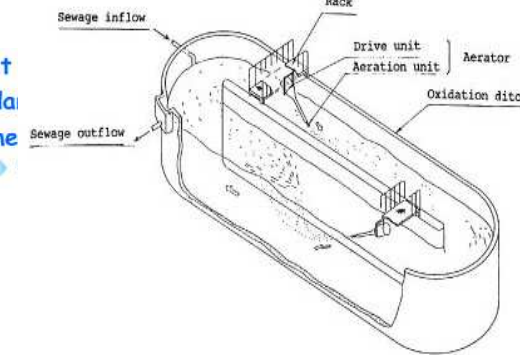
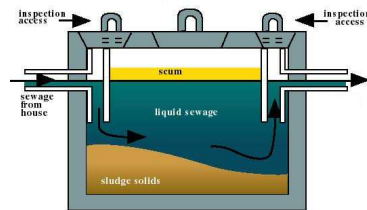
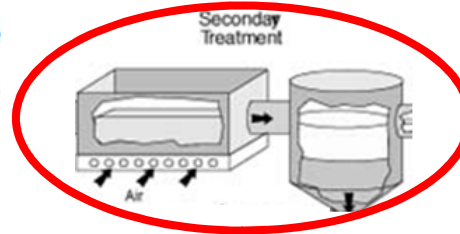
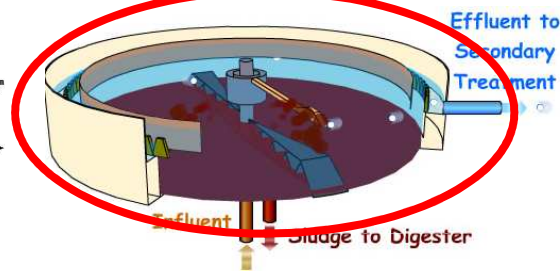
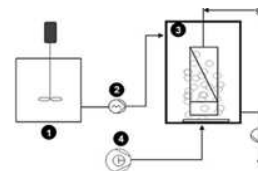
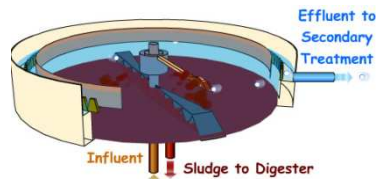
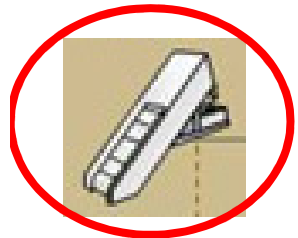

Pretreatment

Primary treatment

Secondary treatment

Sludge treatment



Preliminary results

D214 Part proporcional de les peces especials per a tubs

Partida	Codi	Unitat	Descripció	Nº unitats	Preu Euro	Preu Parcial	Import (€)	Material consumit	Q. material	Unitat
3	GFA		TUBS I ACCESSORIS DE PVC							
4	GFA1		TUBS DE PVC A PRESSIÓ							
7			Tub de PVC de DN 90 mm, per a PN 16 bar, amb unions de junt elàstica, inclòs part proporcional d'accessoris i peces especials d'acer amb protecció contra la corrosió, col·locat al fons de la tuberia i provat							
8	GFA1R309	m								
9	Mà d'obra									
10	A0150000	h	Manobre especialista	0,0534 /R x	19,03000	=	1,01620			
11	A0112000	h	Cap de colla	0,0133 /R x	23,29000	=	0,30976			
12	A0121000	h	Oficial 3a	0,0267 /R x	21,99000	=	0,58713			
13	A013U001	h	Ajudant	0,0000 /R x	19,53000	=	0,00000			
14	A011U001	h	Cap de colla de túnel							
15	A012U001	h	Oficial 3a de túnel							
16	A015U001	h	Manobre especialista de túnel							
17	A0140000	h	Manobre							
19			Subtotal				1,91309		1,91309	
20	Maquinària									
21	C131U028	h	Retroexcavadora de 95 hp, tipus CAT-446 o	0,0000 /R x	58,54000	=	0,00000			
22	C110U025	h	Retroexcavadora de 95 hp, amb martell de 800 kg	0,0000 /R x	72,67000	=	0,00000			
23	C15019U0	h	Camió de 250 hp, de 20 t (9,6 m3)	0,0000 /R x	51,37000	=	0,00000			
24	C1503U10	h	Camió grua de 5 t	0,0043 /R x	41,71000	=	0,17995			
25	C1502U10	h	Camió cisterna de 6000 l	0,0029 /R x	40,01000	=	0,11603			
26	C200U101	h	Bombi per a proves de canonades	0,0029 /R x	3,56000	=	0,01032			
27	C150GU10	h	Grua autopropulsada de 12 t	0,0000 /R x	54,58000	=	0,00000			
28	C211U005	h	Màquina de confecció d'unions soldades de	0,0000 /R x	3,73000	=	0,00000			
29	C139U070	h	Picó vibrant dúplex de 1300 kg	0,0000 /R x	12,86000	=	0,00000			
30	C131U020	h	Retroexcavadora de 50 hp, tipus CAT-416 o	0,0000 /R x	41,30000	=	0,00000			
31	C133U080	h	Picó vibrant amb placa de 60 cm d'amplària	0,0000 /R x	9,06000	=	0,00000			
32	C1A0U001	h	Equip de maquinària auxiliar per a túnels, amb	0,0000 /R x	39,42000	=	0,00000			
33	C1A0U000	h	Robot de gunitat per a túnel (jornada de 24 h)	0,0000 /R x	42,89000	=	0,00000			
34	C1A05U00	h	Jumbo hidràulic de dos braços per a túnel	0,0000 /R x	63,02000	=	0,00000			
35	C131U015	h	Excavadora-carregadora de 110 hp, tipus CAT-212	0,0000 /R x	64,74000	=	0,00000			
36	C211U006	h	Grup electrògen de 600 kVA, amb consums	0,0000 /R x	38,31000	=	0,00000			
37	C1700006	h	Vibrador intern de formigó	0,0000 /R x	1,95000	=	0,00000			
38	C211U001	h	Grup electrògen de 80/100 kVA, amb consums	0,0000 /R x	6,85000	=	0,00000			
39	C15018U0	h	Camió de 350 hp, de 12 t (5,8 m3)	0,0000 /R x	39,24000	=	0,00000			
40	C2005U00	h	Reg. vibratori per a formigonat de soleres	0,0000 /R x	4,10000	=	0,00000			
41	C170AG10	h	Equip de pariments de formigó	0,0000 /R x	53,91000	=	0,00000			

Material description

Necessary workers

Machinery utilized

Different diameters for the same material



Preliminary results

Trench information

Pipe information

Refilling



Preliminary results

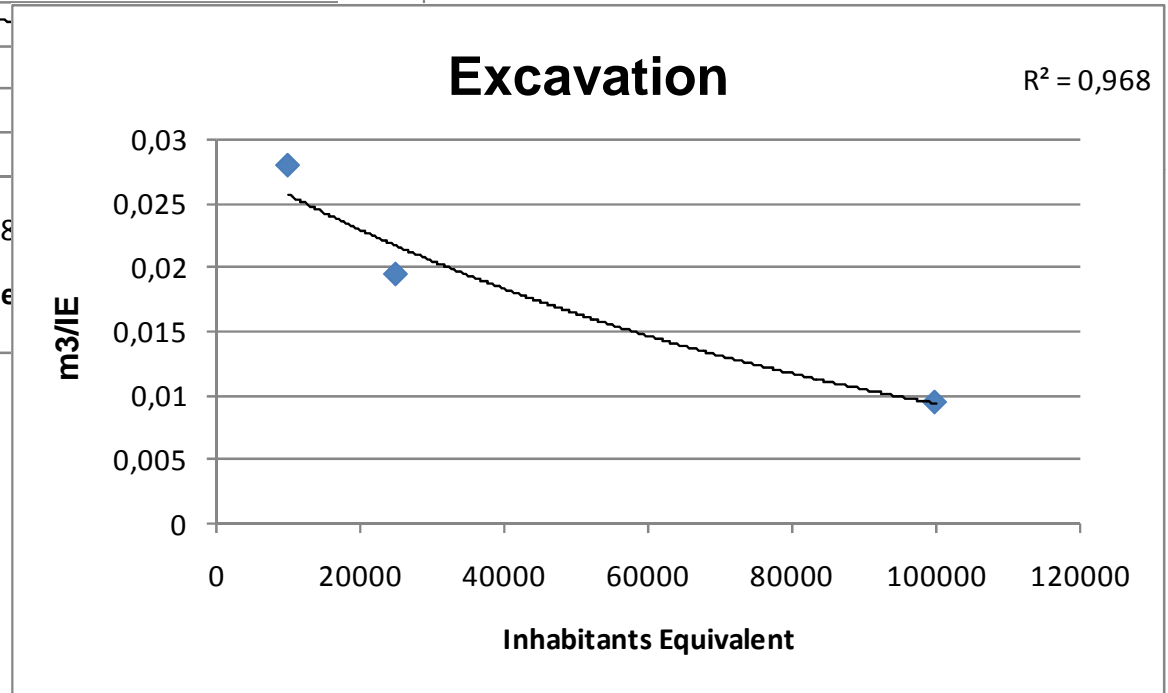
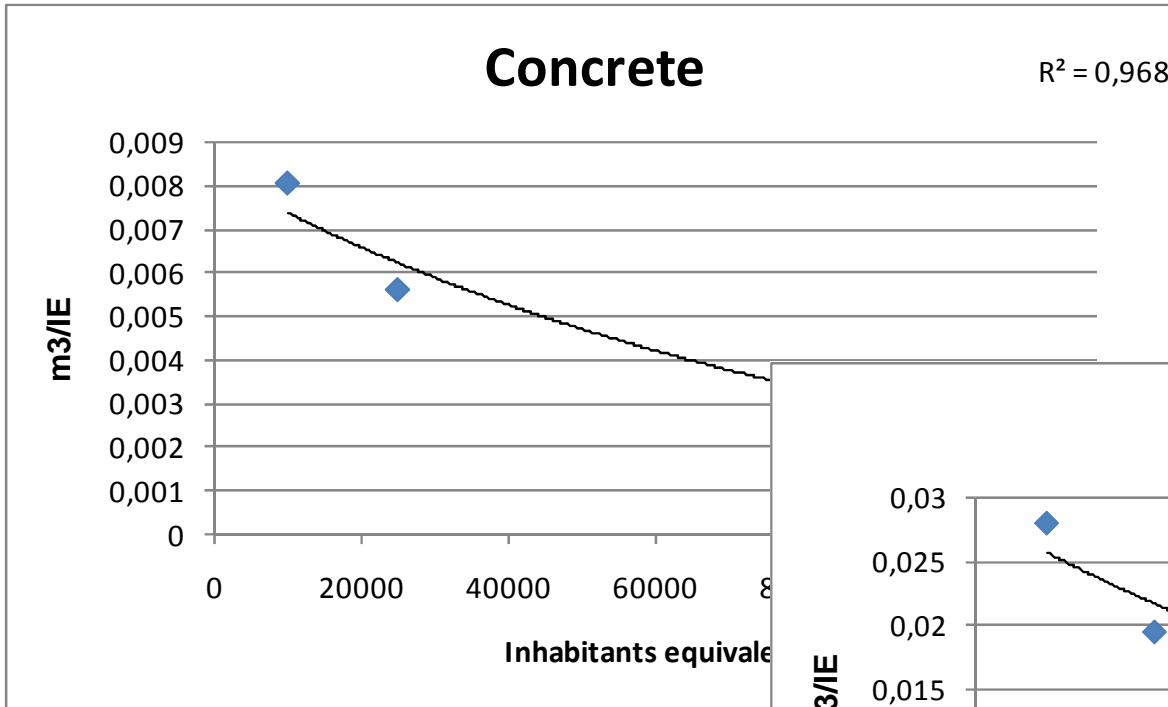

Theoretical calculation for
 primary treatment



Conclusions

- Urban wastewater system assessment should include the sewer system and WWTP.
- Change of the point of view of LCA application towards a modular LCA would be a good option to better understand the different sub-processes of a system.
- LCA users could use this tool to obtain more realistic results when they apply LCA in the urban wastewater system.



Acknowledgements

- EOTECH-SUDOE funds
- VOLTES S.L.U. (sewer system building company)
- Office colleagues



Doubts and questions: sadurni@lequia.udg.cat

